

# C SERIES MANUAL

## Hi-end Car Loudspeaker System

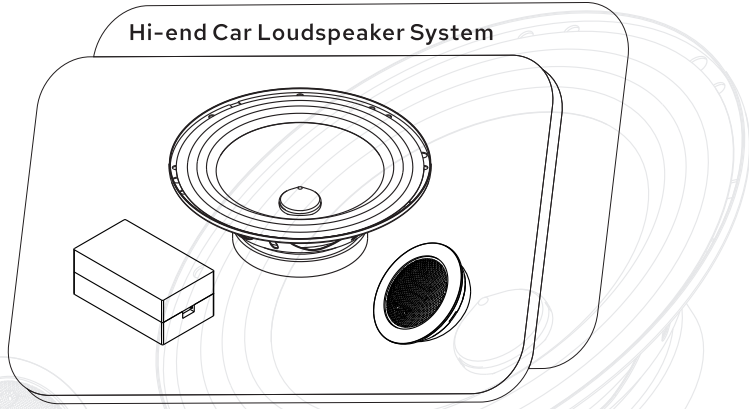

## 6.5" component system

欢迎您选购惠威车用扬声器系统。为了便于您的安装及使用，我们编写本折页。请务必在安装之前，仔细阅读并清楚了解安装程序及注意事项，依据不同型号的扬声器系统，采用不同的安装方式。

虽然本折页说明了安装的方式，但是对于汽车拆装并没有作说明，假如您没有这方面的经验，请不要自行安装，您可以去有经验的汽车服务处进行咨询。

—— 请特别注意您的汽车处于熄火状态！

### 一、线路图：请按照以下线路图连接

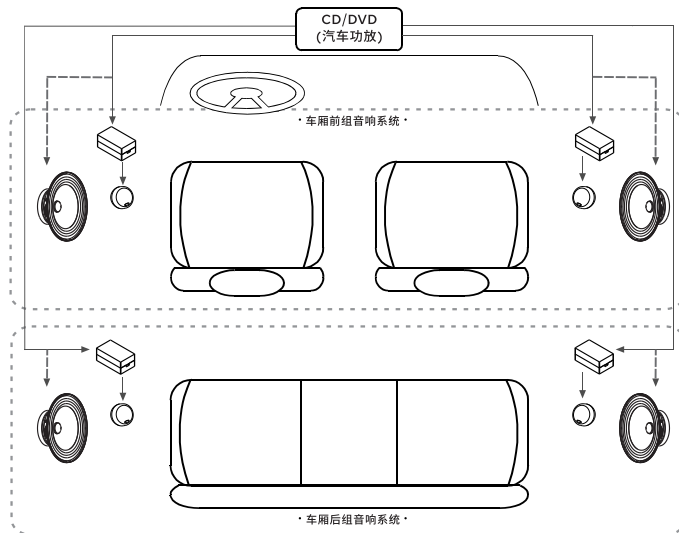

### 二、高音喇叭安装(ACL-1650T)

安装方式一：如不想改变车结构，将高音安装在仪表盘前方或车门边，可以采用此方式。

1. 取半圆形双面自粘EVA，去除一面保护纸后将它粘在高音喇叭的安装位(如图)。
2. 将自粘EVA的另一面保护纸去除，然后将喇叭粘在选定的位置。
3. 调整喇叭方向，以便达到理想的听音效果。

注：此种方法优点在于可以完全不对车进行改变；缺点是不能很牢固的固定高音。

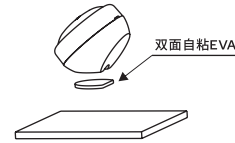

安装方式二：如果需将高音喇叭安装在车门或其它隐蔽的位置，可以采用此方式。

1. 在选定的位置开一约为51mm的圆形孔。
2. 将高音喇叭沉于圆形孔内。
3. 在安装板的背面将螺丝穿过拱形高音安装架锁紧喇叭。
4. 依实际情况，如果安装板比较薄则可以先将3mm单面自粘EVA粘于安装架的脚位。

注：此种安装方式需要在车上打孔，故在安装前需确定高音喇叭的安装位置。

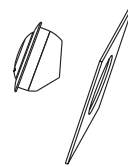

安装方式三：要想牢固地将高音安装在仪表盘前方或车门边可以采用此种安装方式。

1. 先用“一字”螺丝刀将高音喇叭的前盖打开。
2. 按图示将安装螺丝穿过后盖、安装板，将高音喇叭的后盖锁紧在选取的位置。
3. 将喇叭装入后盖内、压紧前盖。
4. 调整喇叭的方向，以便达到理想的听音效果。

注：此种方式需在车上锁螺丝，故在安装前需确定高音喇叭的安装位置。

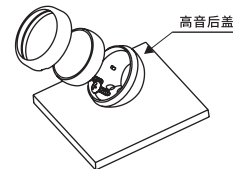

### 三、低音喇叭安装(ACL-1650W)

1. 依实际需要需将密封垫片粘于喇叭的安装位。
2. 将装饰网的网拆除，螺丝穿过装饰网塑料件及喇叭安装孔将喇叭锁紧。
3. 当安装深度不够时，可以在喇叭的安装位加一垫圈以增加安装深度。

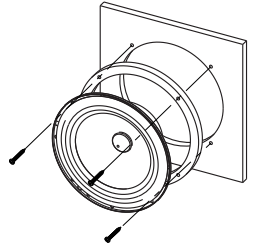

### 四、尺寸图

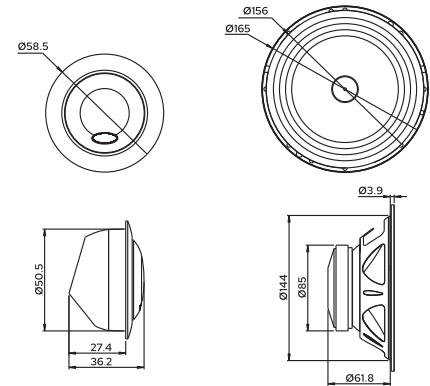

### 五、规格参数

型号	ACL-1650TW
系统组成	6.5"+1"
中低音	6.5"中低音
高音	1"软球顶高音
灵敏度	90dB
频率响应	60-20KHz
最大功率	100W
额定功率	50W
额定阻抗	4Ω
安装尺寸	Ø165
开孔尺寸	Ø144
安装深度	>65
分频点	8KHz
高通衰减斜率	-6dB/Octave
低通衰减斜率	/

惠威车用扬声器系统  
www.hivi.com

# C SERIES MANUAL

## Hi-end Car Loudspeaker System

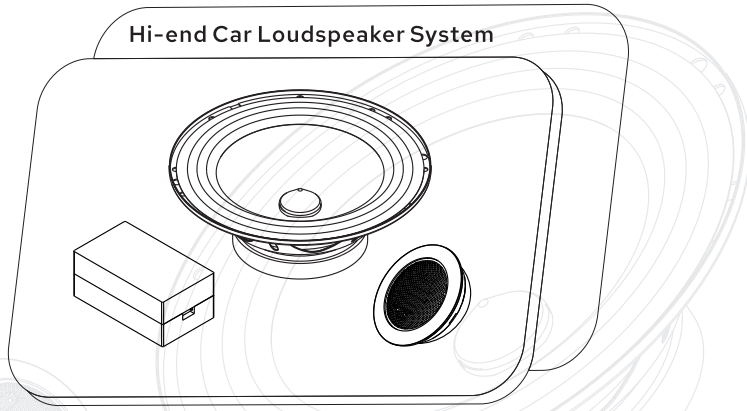

6.5" component system

Thank you for your purchase of HiVi Car-Audio Speaker Systems. Please read the following installation and operation guidelines carefully to ensure many years enjoyment of car audio speaker system. All HiVi Speaker Systems products should be set-up and installed by authorized and licensed technicians. Though this manual narrates the installation, it didn't show the remove of car. If you got no experience of this, please don't set up by yourself. you can inquire at the experienced car service office.

———— Please note your car is on flameout situation!

**Circuit diagram** Please connect according to the following circuit diagram

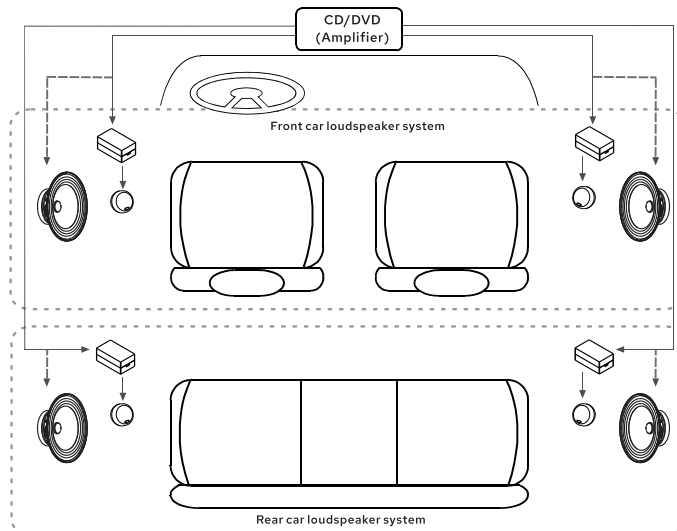

## Installation of Tweeter(ACL-1650T)

Option one: if you don't want to change the structure of car, and install the tweeter before steering wheel or beside the door of car, then you can use this mode.

1. Take semicircle double sides stick EVA, get rid of one side protecting paper and stick this on the place of installation of tweeter (as drawing).
2. Get rid of another protecting paper of EVA, then stick speaker at the fixed place.
3. Adjust the orientation of speaker so as to reach the best sound quality.

Note: The merit of this kind of installation is that don't need to change the car, the demerit is that can't fix the tweeter well enough.

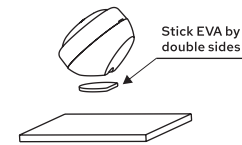

Option Three: if you want to fix the tweeter on the door of car or some other shady place, you can use this kind of installation:

1. Open a round hole about 51mm on the selected place.
2. Sink the tweeter in the round hole.
3. On the back of installation plate, use the snail threading arch tweeter.
4. Actually if the installation plate is very thin, you can use, a 3mm one-side sticking EVA stick at the foot of installation frame.

Note: This kind of installation needs to open holes on the car, so you have to fix the place of tweeter before installation.

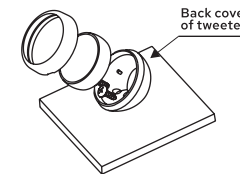
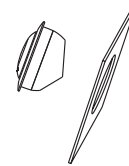

## Installation of Woofer(ACL-1650W)

1. According the demand then stick the airproof mat on the place of installation.
2. According the opening hole template then open the speaker hole and the snail installation hole in suitable place.
3. If the depth is not enough, can use some mats on the place of installation then can add some depth.

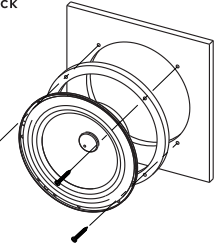

## Dimensions

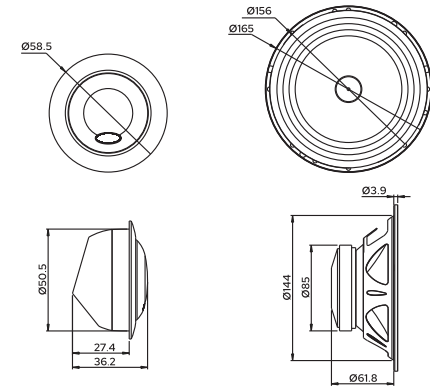

## Specifications

Model	ACL-1650TW
System	6.5"+1"
Woofer	6.5"middle; low sound
Tweeter	1"soft dome tweeter
Sensitivity	90dB
Frequency Response	60-20KHz
Max Power	100W
Power Handling	50W
Rating Impedance	4 Ω
Installation Size	Ø165
Hole Size	Ø144
Installation Depth	>65
Frequency point	8KHz
High pass decay rate	-6dB/Octave
Low pass decay rate	/

HI-END CAR LOUDSPEAKER SYSTEM  
www.hivi.com

Because of design change and other reasons, the data may be physical discrepancies, without notice